

VINTEC



Designed for wine
lovers, by wine lovers

THE COLLECTION

Designed for wine lovers, by wine lovers.

Great wines are crafted with an obsession for quality at each step of the production process. Serious collectors, sommeliers and merchants know how important it is to preserve that quality during long-term cellaring.

They also know that Vintec climate-controlled cellars are the most reliable tools for ensuring their collections are protected.

Created to meet standards of excellence born from a love of wine, they recreate the ideal storage conditions found only in the best natural underground cellars.

Whether you have dusty cases under your stairs or an investment-grade collection, Vintec has the range of capacities and styles to ensure your wine can be enjoyed at its best for many years to come.

Vintec offers a holistic experience for wine lovers: specialized products that provide the perfect cellaring and serving conditions for your wine as well as educational and experiential benefits to enrich your wine journey.

Our private club for owners of Vintec cellars - the Vintec Club - offers unique, exclusive dinners and tastings featuring renown winemakers and rare wines while our proprietary 'OENO' virtual cellar management app helps you manage your collection.

Contents



Introduction

Why choose Vintec?	6
The Vintec story	8
The golden rules of wine storage	10
Features	12
Selecting your wine cellar	14

Underbench Wine Cellars

Single Zone	18
Dual Zone	20

Beverage Centres

Single Zone	24
-------------	----

Tall Wine Cellars

Features	28
Premium Multi Temp	30
Multi Temp	32
Single Zone	33

Walk-in Cellars

Espace	36
--------	----

The Vintec Club

About the club	40
Burgundy, France Tour	44
Private tastings	46
Accessories shop	48

Global Brand Ambassador

Arvid Rosengren	50
-----------------	----

OENO

Virtual cellar manager	52
------------------------	----

Technical Guidelines

Ventilation	58
Capacity	60
Temperature	62
Detailed specifications	64

Warranty

	70
--	----

Why choose Vintec?

Wine cellars are our specialty

In fact, that is all we do. Being intimately connected to the wine industry and focussed solely on wine cabinets for over two decades, we have developed the largest and most advanced range to suit all wine storage requirements.

We care about your collection

Our highest priority is to offer the best and safest storage solution for your wine. For instance, all our cellars have dark interiors and dim UV-free lighting, instead of white interiors and bright lights. Why? Because it's important to keep your wine in a dark storage area.

The Vintec guarantee

All Vintec wine cellars have been tested to ensure they function in Australian and New Zealand climates. Covered by a two year warranty, our cellars bear unique identification numbers that allow their origin and authenticity to be traced. They are also backed by dedicated phone support teams in Sydney and Auckland, as well as a national network of service specialists.

Become a member of the Vintec Club

The Vintec Club is a private club for owners of Vintec wine cellars, offering exclusive benefits around wine. It's also a broader community for all wine lovers who enjoy learning and connecting with other like-minded wine lovers. Joining the club as a 'Guest' is free. To become a 'Member', you need to own and register a Vintec wine cellar.

Find out more on page 40.

Photo: 5x V190SG2E-BK installed at Rockpool, Sydney

The Vintec story

VINTEC

Vintec is a leading specialist brand in climate-controlled wine storage solutions, having gained the trust of professionals, the wine industry and consumers, to become the benchmark in Australia and Asia-Pacific.

Wine is at the heart of everything we do, it's a passion shared with all wine lovers. We know how important a wine collection is; how confusing storing and serving wines can get; and how intimidating learning about wine can be. By providing tools, content and a community, we help guiding wine lovers to continuously rediscover wine.



Heritage

Vintec was born in 2000 from the initiative of two Frenchman who shared a common love for wine and saw climate-controlled wine cabinets as the wine storage solution of the future. The entrepreneurs leveraged their previous experience in the wine industry to collaborate with Danish designers and manufacturers to introduce a range of stylish and functional wine preservation systems.



Products

With a modern Scandinavian-inspired design, Vintec Climate-Controlled Wine Cabinets are engineered to protect wines for the short or long term, optimizing storage space and accessibility while maximizing capacity and providing stunning solutions to showcase a wine collection.



Knowledge

Wine is a complex and ever-evolving beverage that needs the right conditions to develop and be enjoyed at its best - as intended by the winemaker. That's why Vintec Climate-Controlled Wine Cabinets strictly follow the 5 Pillars of Wine Storage.

Vintec. Designed for Wine Lovers, by Wine Lovers.

The Vintec 5 Pillars of Wine Storage

As wine lovers, we know first-hand how important your wine collection is to you. This is why we have spent over 20 years building our range on five core pillars of preservation.

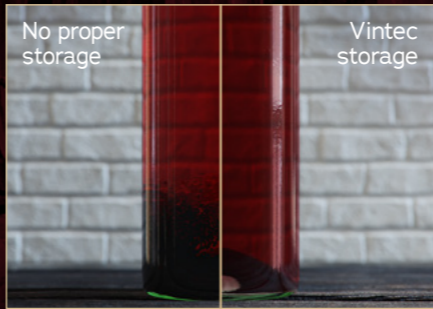

Pillar 1:

Stable temperature

Vintec wine cabinets are specially designed to maintain a constant temperature to preserve your wines, keeping them at their best and allowing them to mature steadily.

- Insulated side panels
- Double / triple-glazed doors

Pillar 2:

Humidity

Vintec wine cabinets are specially designed to maintain a higher humidity than a standard refrigerator to preserve corks and prevent your wine from oxidising while cellaring.

Pillar 3:

UV-proof dark storage area

Vintec wine cabinets are specially designed to prevent UV light from affecting your wine.

- UV-resistant tinted and insulated glass doors
- Dark interiors
- Double / triple-glazed doors
- UV-free LED lighting

Pillar 4:

Vibration-proof environment

Vintec wine cabinets are specially designed to keep all moving parts in suspension, absorbing and reducing to a minimum any vibrations, so that your wines are stored in a protected environment where they can mature steadily.

- Vibration-absorbing
- Sliding shelf rails
- Vibration-absorbing
- Oak and beech wooden shelves

Pillar 5:

Quality airflow

Vintec wine cabinets are equipped with an efficient air circulation system and selected models include an air filter to ensure a constant, slow flow of filtered air throughout the cabinet. This limits odours that can penetrate your wine and prevents mould from growing and damaging labels and corks.

Features

Why a wine cabinet instead of a fridge?

Traditional refrigerators generate intense cold and remove ambient humidity. They denature your wines and dry out corks.

Vintec wine cabinets are designed specifically for the preservation and maturation of your wines.

Our wine cabinets maintain a stable temperature to keep your wine in perfect cellaring conditions. This is thanks to triple glazed

glass, fully insulated cabinet panels and interactions between a compressor and thermostat. (Features may vary by model).

Selected models incorporate a winter heating function. In low ambient temperatures it gently warms the cabinet to ensure a constant year-round temperature is maintained.

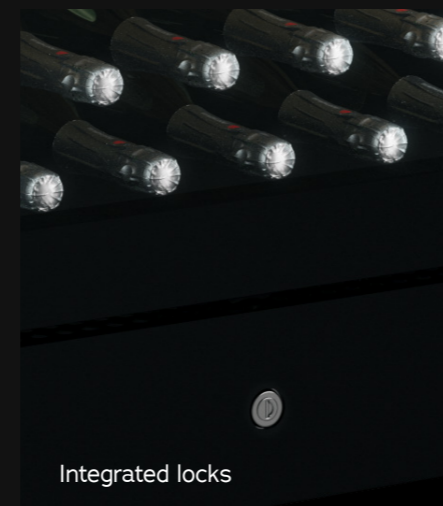

Integrated locks



Adjustable sliding timber anti-vibration shelves



Carbon filters

Caring for the environment as well as your wine

Vintec climate-controlled wine cabinets are equipped with energy-efficient R600a refrigerant gas, which has zero ozone-depleting properties.

The switch to R600a is part of a series of initiatives that Vintec has undertaken in order to limit our carbon footprint and to preserve the environment.



LED lighting, temperature display and control panels

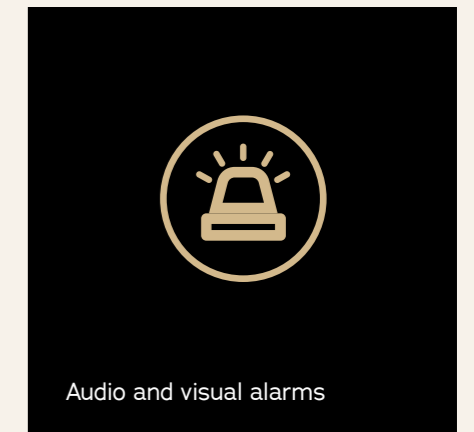

Audio and visual alarms

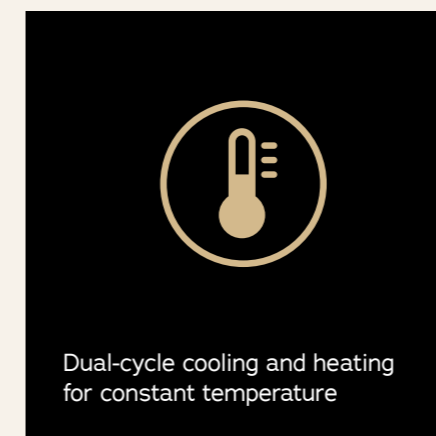

Dual-cycle cooling and heating for constant temperature

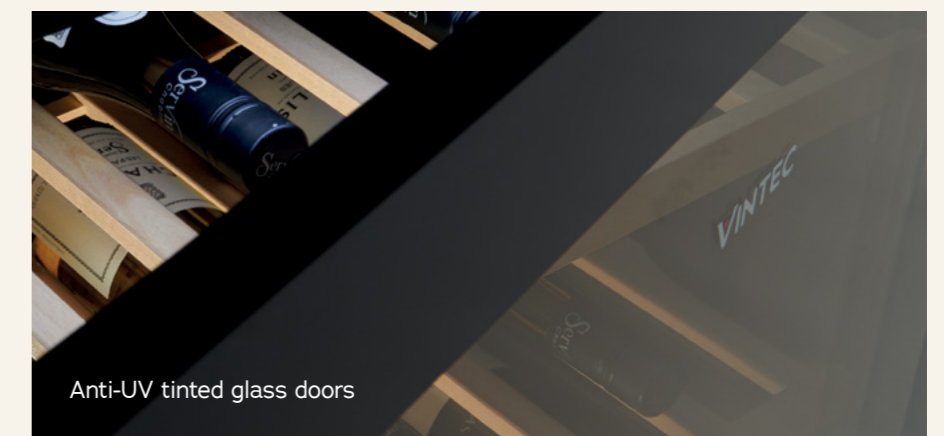

Anti-UV tinted glass doors

*Features/images vary by model.

Selecting your wine cellar

Capacity



Underbench Wine Cellars
20 - 50 bottles

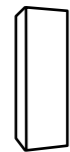

Tall Wine Cellars
100 - 300 bottles

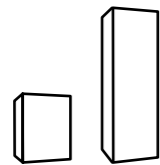

Beverage Centres
40 - 250 beer bottles

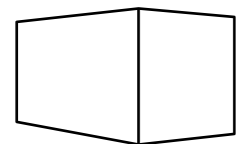

Walk-in Cellars
600 - 4000 bottles

Capacities expressed are based on that achieved in our testing using standard 750ml Bordeaux style wine bottles (see page 54 for dimensions) or 330ml beer bottles. Our cellars can accommodate other shapes and sizes of bottles, however their inclusion will affect overall maximum capacity.



Easy:
Capacity that can be reached with all supplied shelves installed and with a maximum of 4 - 5 levels of stacking per shelf.

Max:
Maximum capacity that can be reached. For some models, reaching this capacity requires using less shelves than supplied.

Design

Vintec wine cellars are available in 3 stylish finishes to suit your décor



Borderless Black Glass



Stainless Steel



Matte Black

Function



Single Zone

Since all wines – reds, whites and Champagne – cellar at the same temperature (12° - 14°C), a Single Zone cellar is ideal for conveniently storing and cellaring all your wines. Alternatively, a Single Zone cellar can be used to serve wines at optimal drinking temperatures: either 6° - 8° for white, or 16° - 18° for red.



Dual Zone

A Dual Zone cellar is ideal for keeping both reds and whites at optimal respective drinking temperatures. Set one compartment at 6° - 8°C for whites and Champagne, and the other at 16° - 18° for reds. Alternatively, one compartment can be set at a serving temperature and the other at 12° - 14° for cellaring.



Multi Temp

Vintec's versatile Multi Temp technology is designed for serving different styles or varietals at their optimal individual drinking temperatures. For instance, setting the bottom at 6°C and the top at 18° generates a temperature gradient throughout the cellar allowing you to keep several different varietals all stored at their optimal drinking temperatures.



20 - 50

You love to entertain at home and it's important that your guests are well received. Vintec underbench wine cellars balance convenience with style, providing the same technical precision of their larger cousins in a more compact size. Have your best wines on hand at perfect serving temperatures ready to be enjoyed, or cellar a small collection with confidence.

Underbench Wine Cellars



Single Zone Wine Cellars

Since all wines – red, white and sparkling – cellar at the same temperature (12°), the Single-Zone wine cabinets are ideal for storing and cellaring for short or long-term. The Single-Zone can also be used for storing wines at drinking temperatures: 6-8° for sparkling, 8-13° for whites, 15-18° for reds.

50 Bottle capacity cellars

Underbench or freestanding



Max: 50
Easy: 40

VWS050SBB



VWS050SSB



- Adjustable/Repositionable Shelves
- Triple-Glazed Door with Anti-UV Glass
- LED Digital Display Panel
- Humidity Recycling System
- Security Lock
- Reversible Door
- Energy-Efficient R600a Gas

- Adjustable/Repositionable Shelves
- Triple-Glazed Door with Anti-UV Glass
- LED Digital Display Panel
- Humidity Recycling System
- Security Lock
- Reversible Door
- Energy-Efficient R600a Gas

35 Bottle capacity cellars

Freestanding only



Max: 35
Easy: 28

VWS035SBB

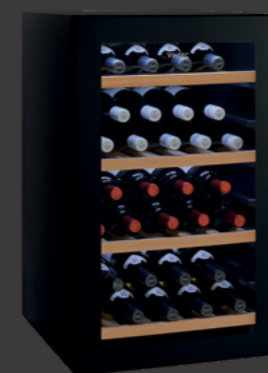

VWS035SSB



- FREESTANDING ONLY**
- Adjustable/Repositionable Shelves
- Triple-Glazed Door with Anti-UV Glass
- LED Digital Display Panel
- Humidity Recycling System
- Reversible Door
- Energy-Efficient R600a Gas

- FREESTANDING ONLY**
- Adjustable/Repositionable Shelves
- Triple-Glazed Door with Anti-UV Glass
- LED Digital Display Panel
- Humidity Recycling System
- Reversible Door
- Energy-Efficient R600a Gas

20 Bottle capacity cellar

Underbench / freestanding



Max: 20
Easy: 18

VWS020SBB

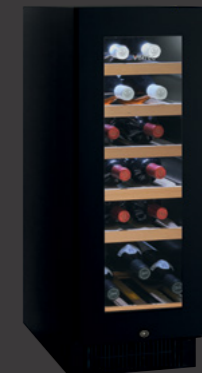

- Adjustable/Repositionable Shelves
- Triple-Glazed Door with Anti-UV Glass
- LED Digital Display Panel
- Humidity Recycling System
- Security Lock
- Reversible Door
- Energy-Efficient R600a Gas



Dual Zone Wine Cellars

The Dual-Zone wine cabinets are ideal for keeping wines – red, white and/or sparkling – at optimal respective drinking temperatures. Set one independent zone at 6-13° for sparkling or white wines, and the other at 15-18° for reds. Alternatively, keep one or both zones at cellaring temperature (12°) to mature wines steadily.

50 Bottle capacity wine cellars

50-bottle Dual-Zone wine cabinets can be set for serving reds and whites at different temperatures OR cellaring and serving wines.



Max: 50
Easy: 40

VWDO5OSBB



VWDO5OSSB



- Adjustable/Repositionable Shelves
- Triple-Glazed Door with Anti-UV Glass
- LED Digital Display Panel
- Humidity Recycling System
- Security Lock
- Reversible Door
- Energy-Efficient R600a Gas

- Adjustable/Repositionable Shelves
- Triple-Glazed Door with Anti-UV Glass
- LED Digital Display Panel
- Humidity Recycling System
- Security Lock
- Reversible Door
- Energy-Efficient R600a Gas



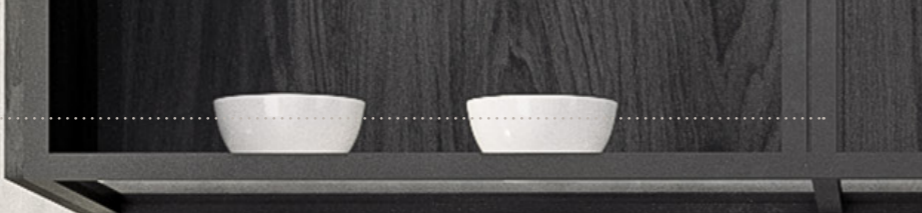

100 - 250

Our Beverage Centres offer the perfect solution for storing Champagne, white wine, beer and soft drinks, ready for serving.

Beverage Centres





Single Zone Beverage Centres

Perfect for entertaining, the Beverage Centre keeps beer cold at 2° - 5°C and chills white wines and Champagne for serving.

250 beer bottle capacity beverage centre

Slot-in or freestanding



Max: 250
Easy: 200
(330ml beer)

V190BVC-BK



-  Double-Glazed Door with Anti-UV Glass
-  Adjustable Shelves
-  Audio and Visual alarm
-  Digital Temperature Display
-  LED Internal Lighting

100 beer bottle capacity beverage centre





Underbench or freestanding



Max: 100
Easy: 70
(330ml beer)





VBS050SBB



-  Triple-Glazed Door with Anti-UV Glass
-  LED Digital Display Panel
-  Security Lock
-  Reversible Door

VBS050SSB



-  Triple-Glazed Door with Anti-UV Glass
-  LED Digital Display Panel
-  Security Lock
-  Reversible Door

40 beer bottle capacity beverage centre





Underbench or freestanding



Max: 40
Easy: 35
(330ml beer)

VBS020SBB



-  Triple-Glazed Door with Anti-UV Glass
-  LED Digital Display Panel
-  Security Lock
-  Reversible Door



100 - 300

You collect and consume the finest wines; therefore you should have the best storage and serving solution available. From ageing to serving, a tall Vintec wine cellar is the answer to every wine connoisseur's dream.

Tall Wine Cellars

The most recent addition to our range is Vintec Premium Wine Cabinets, so that wine lovers can store their entire wine collections and accommodate all main bottle shapes – even Champagne.

Tall Wine Cellars

Unique Premium Range Features



Featuring the proprietary **Perfect Cradle™ Shelving**, which is a new shelving system designed to fit comfortably all bottles of your diverse collection, including your favorite Champagne and even standard Magnums, without scratching labels. The carefully optimised storage space provides easy access and visibility to all bottles, as well as stunning ways to showcase a collection



Wide-Slat, Fully-Extendable Telescopic Shelves provide visibility and easy access to bottles, Reversible Shelves accommodate bottles on upright position with a Top Display Shelf to elegantly showcase your collection.



Made in Europe, with a modern Scandinavian-inspired design, this Vintec range of climate-controlled wine cellars is the perfect solution for all wine lovers and collectors to protect and store their treasured collections.



Premium Multi-Temp Wine Cellars

The Multi-Temperature setup feature allows you to store all your different wine varieties at their perfect drinking temperatures - ready to be served at any time. For cellaring, the range is equipped with a unique Cellaring Mode which sets the temperature of the entire wine cellar at 12 degrees Celsius - the ideal temperature to cellar all wine varieties and styles

Premium models feature stylish matte glass finish, inverter compressor, touch controls and oak shelves with anodised metal trim to securely cradle your precious wine. Available in 2 sizes with configurations for maximum capacity and easy access to suit your individual needs.



Max: 180
Easy: 150

VWM306PBA



- Extra Wide Shelf Cradles
- Fully Extendable Shelves on Telescopic Runners
- Inverter Compressor
- Top Reversible Shelf
- Soft Close
- Double-Glaze Door with Anti-UV Glass
- Top-to-Bottom LED Lighting
- LED Digital Display Panel
- Humidity Recycling System
- Audio & Visual Alert
- Security Lock



Max: 306
Easy: 210

VWM306SBA



- Extra Wide Shelf Cradles
- Reversible Shelves
- Inverter Compressor
- Adjustable/Repositionable Shelves
- Soft Close
- Double-Glaze Door with Anti-UV Glass
- Top-to-Bottom LED Lighting
- LED Digital Display Panel
- Humidity Recycling System
- Audio & Visual Alert
- Security Lock



Max: 126
Easy: 110

VWM198PBA



- Extra Wide Shelf Cradles
- Fully Extendable Shelves on Telescopic Runners
- Inverter Compressor
- Wine Display Shelf
- Soft Close
- Double-Glaze Door with Anti-UV Glass
- Top-to-Bottom LED Lighting
- LED Digital Display Panel
- Humidity Recycling System
- Audio & Visual Alert
- Security Lock



Max: 198
Easy: 130

VWM198SBA



- Extra Wide Shelf Cradles
- Reversible Shelves
- Inverter Compressor
- Wine Display Shelf
- Soft Close
- Double-Glaze Door with Anti-UV Glass
- Top-to-Bottom LED Lighting
- LED Digital Display Panel
- Humidity Recycling System
- Audio & Visual Alert
- Security Lock



Multi-Temp Wine Cellars







In Multi-Temp mode, the cabinet generates a gradient of temperatures from top-to-bottom, allowing you to store different wine styles and varietals at their perfect serving temperatures – typically graduating from 6° at the bottom to 18° at the top. True Multi-Temp™ offers a wider range of temperatures with greater control, unlike most wine cabinet brands: at the top between 12° to 18°, and at the bottom between 6° to 12°.



Max: 198
Easy: 130

V190SG2E-BK





-  Adjustable/Repositionable Shelves
-  Double-Glazed Door with Anti-UV Glass
-  Top-to-Bottom LED Lighting
-  LED Digital Display Panel
-  Humidity Recycling System
-  Audio & Visual Alert
-  Security Lock

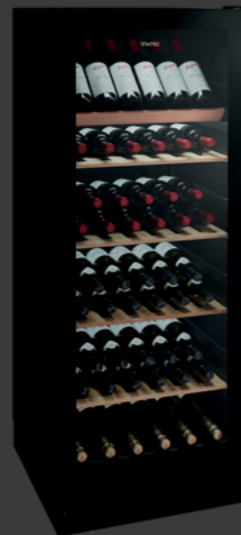

Max: 148
Easy: 80

VWM148SBA



-  Adjustable/Repositionable Shelves
-  Double-Glazed Door with Anti-UV Glass
-  Top Crystal White LED Lighting
-  LED Digital Display Panel
-  Humidity Recycling System
-  Audio & Visual Alert
-  Security Lock



Single Zone Wine Cellars

Since all wines – red, white and sparkling – cellar at the same temperature (12°), the Single-Zone wine cabinets are ideal for storing and cellaring for short or long-term.







The Single-Zone can also be used for storing wines at drinking temperatures: 6-8° for sparkling, 8-13° for whites, 15-18° for reds.



Max: 170
Easy: 155

VWS17OSSB





-  Triple glazed door with anti-UV glass
-  Slide-out wooden shelves
-  Security lock
-  Reversible door
-  Digital temperature display
-  LED internal lighting
-  Winter function (heating system)



Max: 130
Easy: 110

VWS13OSSB



-  Triple glazed door with anti-UV glass
-  Slide-out wooden shelves
-  Security lock
-  Reversible door
-  Digital temperature display
-  LED internal lighting
-  Winter function (heating system)



600 - 4000

The environmental simulation of an underground cave. Not only does it recreate the ideal storage conditions for large collections, but true connoisseurs will discover the unique feeling of physically walking into their own treasured cellar.

Walk-in Cellars

TRANSTHERM



Transtherm Space

The Transtherm Space Walk-In Cellars is the ultimate in luxury for the serious collector or industry professional. A Walk-In cellar is the modern and technological equivalent of an underground cellar. Not only does it recreate the perfect cellaring conditions for large collections, but true connoisseurs will also rediscover the special and unique feeling which is to walk into ones treasured cellar.

These beautiful Walk-In cellars have been hand-built in France for over 20 years from quality materials, with storage capacities from 600 to 4000+ bottles. They come delivered flat-packed, and can be built into your home in less than half a day, and can be disassembled if you relocate. They also come with a modular extension pack which can provide more space as your collection grows.



Max: 1000

ESPACE1000-KIT



Extension packs:

Increase your capacity in 500 bottle increments, up to a maximum of 4000 bottles. Packs include cabinet extension panels and additional shelving.



ESPACE1500-KIT	Max: 1500
ESPACE2000-KIT	Max: 2000
ESPACE2500-KIT	Max: 2500
ESPACE3000-KIT	Max: 3000
ESPACE3500-KIT	Max: 3500
ESPACE4000-KIT	Max: 4000



- Double glazed door with anti-UV glass
- Sliding and lockable shelving
- Thermal recycling pump - ensures adequate humidity levels above 50% are maintained
- Security lock
- Digital temperature display
- Insulated side panels - maintain a stable temperature





VINTEC CLUB

VINTEC CLUB

The Vintec Club is the private club for owners of Vintec wine cellars and an open community for wine lovers.

Purchasing any cellar entitles you to lifetime membership – our way of saying thank you to our discerning and valued customers who invariably love wine.

To find out more or become a member, go to vintecclub.com

My VINTEC

My Vintec is a Member-only personalised wine program. Each month Vintec Club members are emailed helpful information, tips and VIP offers to enhance their understanding of Collecting, Cellaring and Serving wine and ultimately, making the best use of their Vintec wine cabinet.

Member privileges



Exclusive Experiences

Members of the Vintec Club receive exclusive invitations to unique wine experiences. The Residency program allows you to not only meet the celebrated winemakers in a relaxed atmosphere, but savour the wines together with delicious food in some of the best restaurants in every state. These private events are subsidized to bring members exceptional experiences at nominal prices.



Concierge

Members of the Vintec Club have access to a dedicated Concierge service for cellar management tips, service requests, benefit enquiries and tastings bookings.



Vintec Club content and Podcasts

Learn about the Art of Collecting, Cellaring and Serving Wine in the Vintec Club Podcast. Discover well-established and up and coming winemakers from around the world; get tips to start and build your wine collection; understand the ideal cellaring time and service temperature for your wines; get inspired by the most delicious wine & food pairings.



Other Member benefits from Vintec Club partners:



Lifetime membership, your own Personal Fine Wine Broker, a \$100 voucher* to spend on fine wine and access to the Langton's Auction & Exchange platforms.



Ongoing 20% VIP discount on Riedel glassware, decanters and accessories.



* min. spend required

VINTEC CLUB

PRIVATE TASTINGS



VINTEC CLUB



Burgundy, France Tour

A once-in-a-lifetime
experience for
20 lucky Vintec
Club Members

Burgundy, France Tour

A once-in-a-lifetime experience for 20 lucky Vintec Club Members

The Vintec Club celebrated its 10th Anniversary in 2022 with a luxurious tour in the heart of arguably the most prestigious wine region in the world, Burgundy, France. 20 Vintec Club Members were lucky enough to visit boutique wineries that rarely open to the public, meeting renowned local winemakers, tasting some of the greatest wines in the world and immersing in the true French Art de Vivre over 6 days. These are the types of exclusive experiences you can expect the Vintec Club to offer when you become a member.

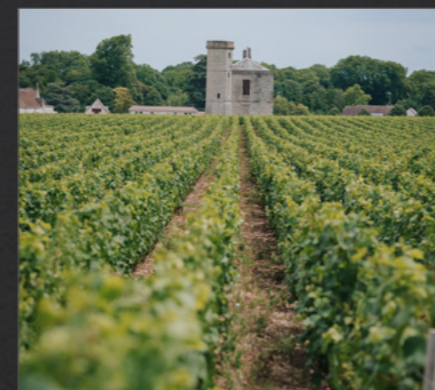

VINTEC CLUB

SHOP

The Vintec Club Shop is an exciting treasure trove of beautiful and functional accessories to enhance your wine appreciation. From serving and preserving to glassware and tableware, every item in our range is a collectible statement of style.

Vintec Club members receive generous discounts, as well as access to rare and limited edition items.

shop.vintecclub.com



VIP

RIEDEL VIP

Ongoing 20% VIP discount, plus free nationwide delivery.

\$

SPECIAL PRICES

Access to special prices for club members on all shop items.

M

MEMBERS AREA

Access to rare and limited edition items.

Browse today at

shop.vintecclub.com



FEATURED BRANDS:



Professor Claus J. Riedel was the first to recognise that the bouquet and balance of wines are affected by the shape of the glass. Riedel is now recognised worldwide for designing and producing the highest quality glassware for the enjoyment of wine.



Legnoart was born out of love and passion for wood and beauty. After almost seventy years, Legnoart is among the major Italian companies in the household, kitchen and cellar furniture design business, and is distributed in over 52 countries.



ÜILO

Üilo is a revolutionary wine purifier that restores the natural taste of wine with Selective Sulfite Capture™ filter technology. Breathe life into reds, or maintain the balance of whites. Twist the aerator on or off to suit your preference.



winesave®

For over a decade, Winesave has helped preserve millions of bottles of wine all around the world. Winesave PRO is made with 100% all-natural, high-quality, food-grade argon gas and is guaranteed to allow you to savour your opened bottles of wine for longer, with just a one second application.

Arvid Rosengren

Global Brand Ambassador

Meet Vintec's global brand ambassador, **Arvid Rosengren**, ASI (International Sommelier Association) World's Best Sommelier 2016. Arvid brings a new level of wine expertise and professional authority to the Vintec brand and will offer Vintec customers exclusive advice on great wines to collect and how to enjoy them at their best. Arvid has been the Global Ambassador for Vintec since 2020.

Born and raised in the south of Sweden, Arvid Rosengren is one of the most merited Sommeliers in the world having accumulated a series of titles over the years, including the latest and most renowned one, Best Sommelier in The World.

After studying at Grythyttan School of Hospitality & Culinary Arts, and working at various places in Scandinavia, Arvid settled in Copenhagen, Denmark where he spent six years, growing from a floor Sommelier of a busy restaurant to Wine Director for an ambitious group of almost a dozen establishments.

It was during this same period that Arvid started his career in competing. After enrolling to his first ever contest, the Best Sommelier in Sweden, in 2009 and getting 2nd place, he was immediately hooked. He went off to claim in the same year the title of Best Sommelier in the Nordics and came back to take the Swedish title in the next year. After three years of intense studying he conquered highly competitive title of Best Sommelier in Europe, 2013.

Nearing thirty, Arvid had become a bit restless and needed to get away from spreadsheets and negotiations and back on the floor, with the guests and the bottles. After meeting a group of winemakers on a gastronomical trip of Scandinavia, he moved to New York, where he worked in SoHo for a couple of years, spending most nights hustling bottles at Charlie Bird, and later co-founded the acclaimed restaurant Legacy Records.

In 2016 he went to Argentina to compete with other 60 top sommeliers from around the world for the title of World's Best Sommelier. The competition is only held every three years and since its inception in 1969 there had only been 14 who have claimed the title. After four days of grueling tests of knowledge, service and blind tasting skills, ending with a final in front of a live audience and live streamed to the world, Arvid Rosengren became the 15th ever to earn the title of Best Sommelier of the World.

Since 2015, Arvid runs King Street Sommeliers, a consulting company focused on cellar management and wine experiences for private collectors and hospitality clients.



“Vintec wine cabinets are engineered to keep wines safe and maturing at a gentle pace, recreating the ideal conditions for long- and short-term storage. The OENO app allows any wine lover to understand and track their collection, and enjoy their wines at their best.”

Arvid Rosengren
Global Brand Ambassador



OENO
BY VINTEC

**Your Virtual Wine
Cellar Manager and
Personal Sommelier**



OENO

BY VINTEC

OENO By Vintec is your virtual cellar management app and personal sommelier, powered by Vivino.

With OENO, you can effortlessly keep track of which wines you have, where they are located in your Vintec cellar(s) and learn how to enjoy them at their best with expert recommendations.

ABOUT 'OENO':

The app is named OENO ('eno') after the Goddess of Wine. According to Greek mythology, Oeno was the great-granddaughter of Dionysus, God of the Grape Harvest and Winemaking, who gave her the power to transform water into wine.

Nowadays, 'Oeno' (UK) is commonly used as a prefix for words semantically connected to wine such as in oenology (the study of wine) or oenophile (a wine lover).

HOW IT WORKS:

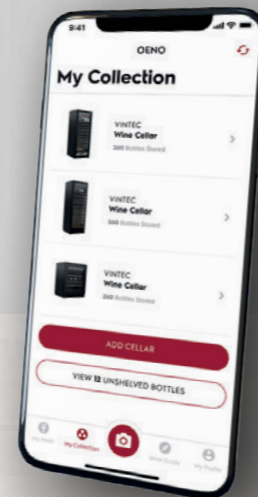

1 CREATE a virtual replica of your wine cellar(s):



2 SCAN labels and see detailed information about wines

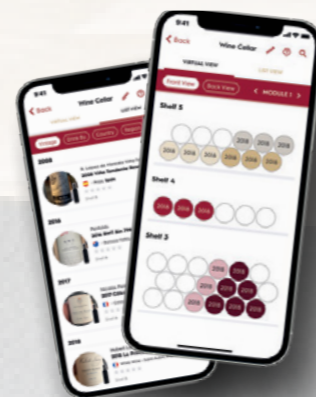

3 MANAGE you collection and keep track of your bottles

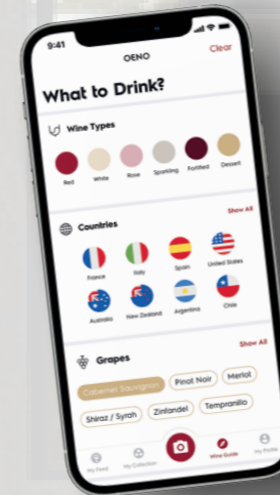

4 PAIR wine and food. Get recommendations of wines from your cellar to match your meals

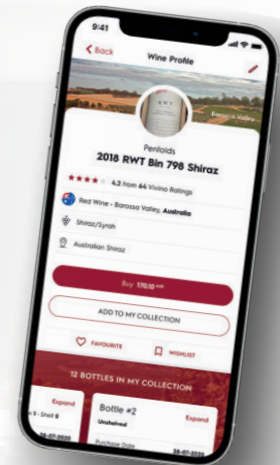

5 BUY wines and restock your collection directly from the OENO app
(Powered by the Vivino Market)

HOW TO ACCESS OENO:

1 DOWNLOAD 'OENO by Vintec' from the App Store or Google Play:



3 'MY COLLECTION' will display your registered cellar(s)

✓ VOILÀ!
You're ready to start!

2 SIGN UP using your Vintec Club account email address

TIP:
Use the multi-scan tool to quickly scan and place a large number of bottles on your cellar



Technical Guidelines

Ventilation

All Vintec cellars are equipped with compressors that generate heat and therefore require a minimum ventilation gap when building them into cabinetry, or positioning them under benches or adjacent to other appliances. The diagrams on these pages are a guide to assist purchasing selection, but detailed, model-specific ventilation requirements

should be obtained from our website at vintec.com prior to installation. A ventilation grill must be installed for any cabinet built under bench or into cabinetry.

Outdoor/alfresco use

Units being installed in outdoor/alfresco areas must be kept out of direct sunlight and away from rain.

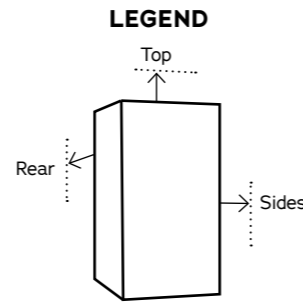

LEGEND
 Illustrations not to scale.
 All dimensions in millimetres.

VWM148/198/306 models

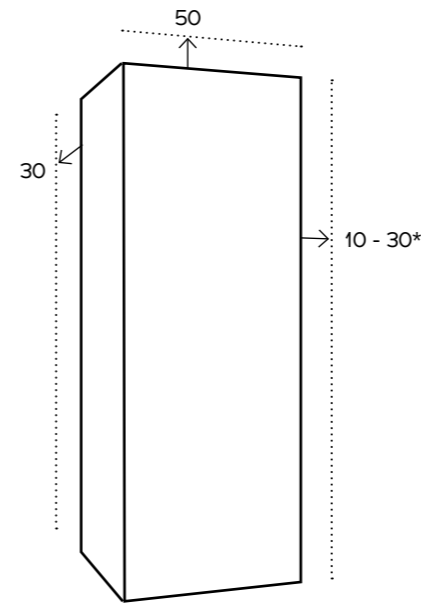

V190 models

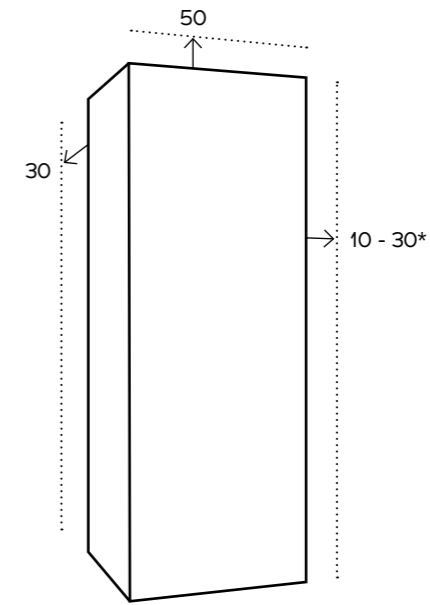

VWS130/170 models

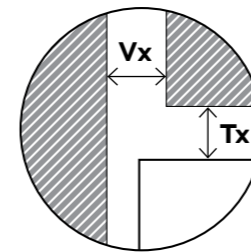
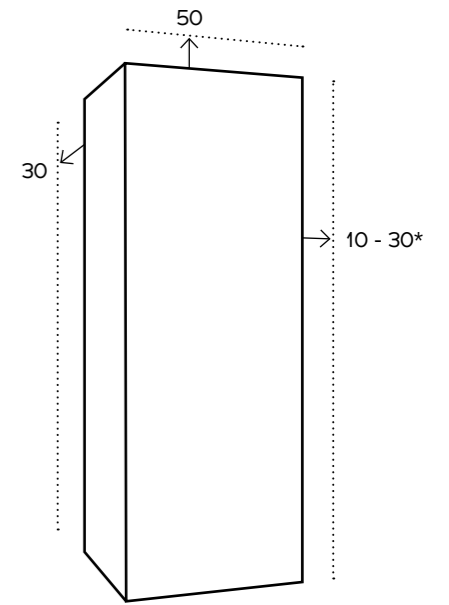

Note: If a vertical vent space (Vx) of 100mm is provided, then a minimum top ventilation gap (Tx) of 50mm is sufficient, but otherwise minimum Tx of 100mm is required.

* Extra space is recommended on the opening edge/top for easy finger grip access, as well as on the hinge side to allow doors to open wide enough for shelves to slide out.

VBS/VWS020 models

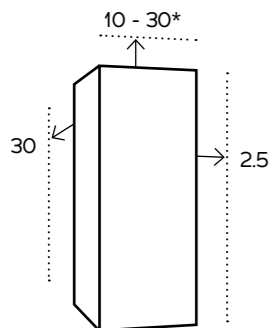

VWS035 models

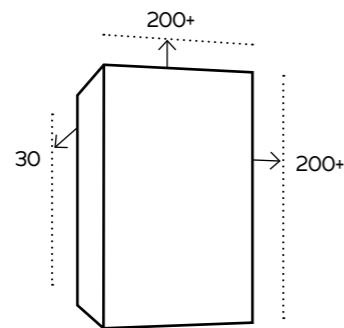

VBS/VWD/VWS050 models

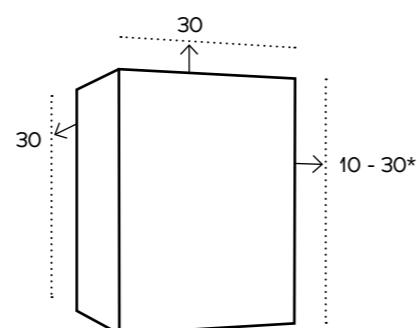

* Extra space is recommended on the opening edge/top for easy finger grip access, as well as on the hinge side to allow doors to open wide enough for shelves to slide out.

Underbench installation

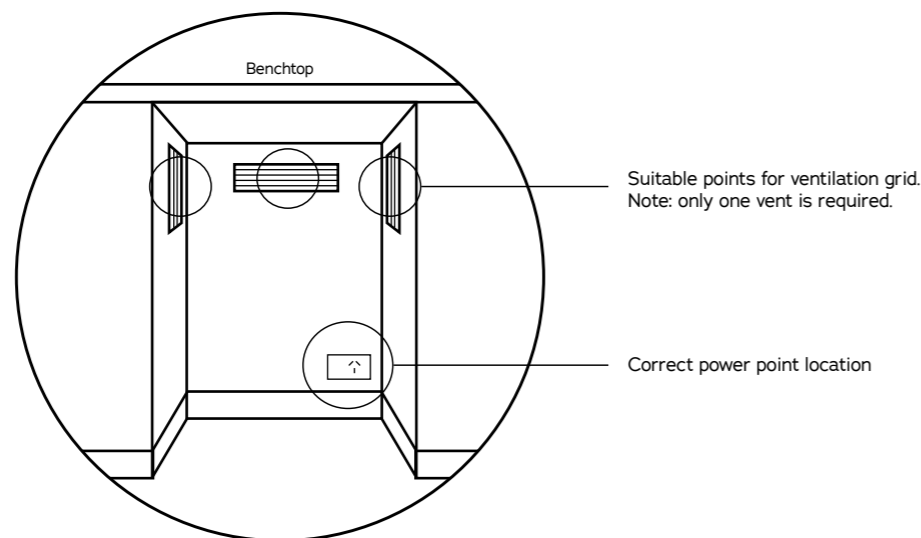

Walk-in Cellar models

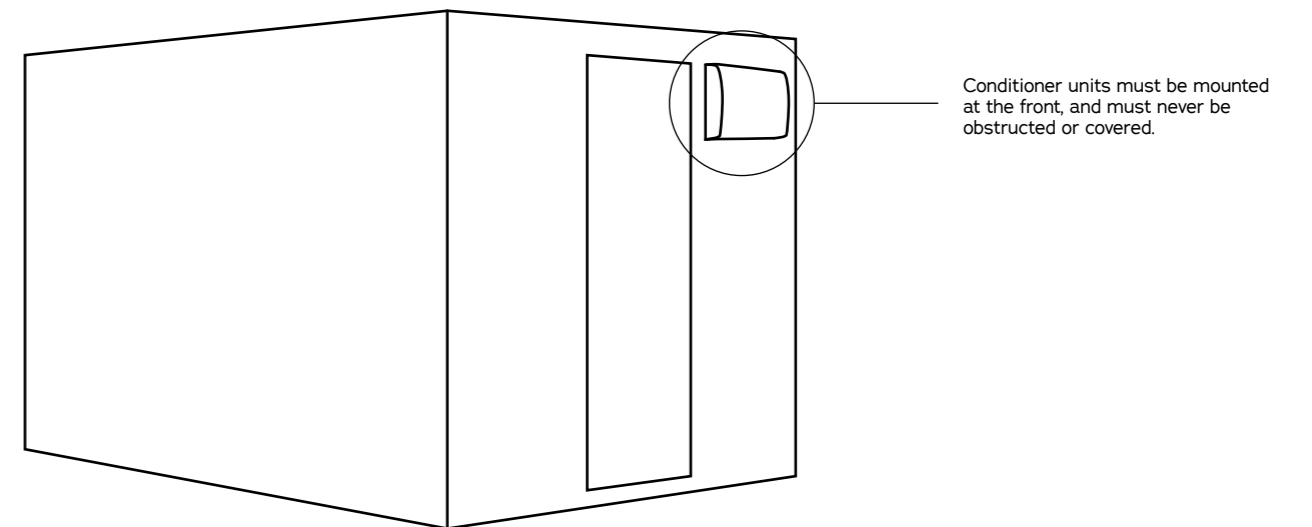

Capacity and shelf stacking

Different shapes and sizes

This brochure makes reference to the 'standard Bordeaux style bottle' when specifying capacity. The dimensions and proportions of this bottle shape are shown at 1. However, wine producers use a huge range of different bottle shapes and sizes, some of which are shown at 2.

Bottle shape variety should be considered when selecting the appropriate Vintec cabinet in which to house your precious collection, since shelf height and adjustability varies across the product range.

The Vintec Premium cabinets offer the Proprietary Perfect Cradle Shelving System, which fits ALL bottle types without scratching labels.

Please also be aware that some bottles will not fit opposite each other on the same shelf and this may affect capacity. You may need to lay the bottles opposite more suitably shaped bottles.

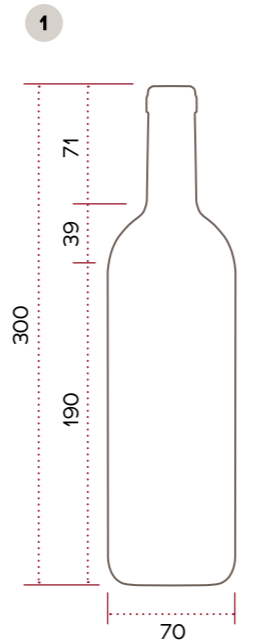

Standard Bordeaux style bottle dimensions



Standard Bordeaux style

Maximum capacity is based on our testing using standard 750ml Bordeaux style wine bottles. Our cellars can accommodate other shapes and sizes of bottles however this will result in a reduction in maximum capacity.

NOTE: Illustrations not to scale.
All dimensions in millimetres.

Stacking for ageing

When filling your cabinet, we suggest stacking the bottles you wish to cellar and mature at the back of the shelves, and the wines you wish to consume in the short-term at the front (see below).

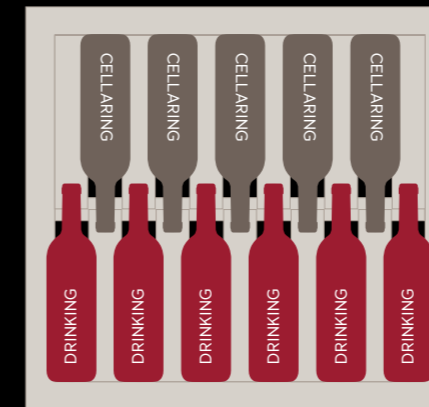

Shelf top view

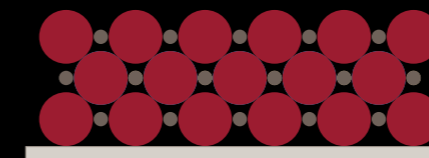

Shelf front view

NOTE: Images are illustrative only and will vary with bottle style and model.

Stacking for accessibility

When stacking bottles, it is practical to keep bottles from the same case together. See diagrams below, in which bottles from the same case are represented by the same colours.

Vertically stacking same-case bottles enables safe and easy access to all your different wines.

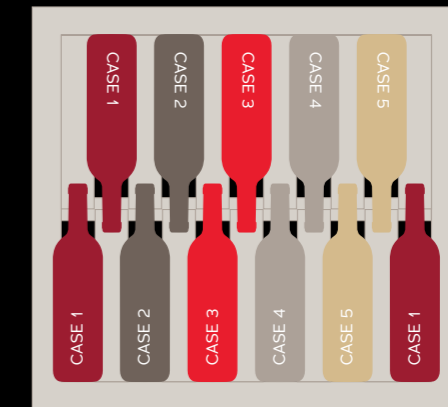

Shelf top view

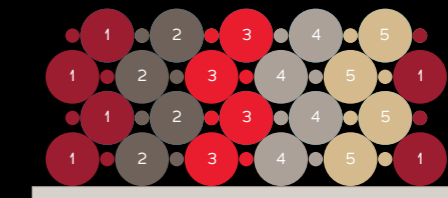

Shelf front view

Cellaring and serving temperatures

Although all wines – reds, whites and Champagnes – should be cellared at the same temperature, different wines have different ideal serving temperatures. Cellar and serve your wines according to the chart below in order to always enjoy your wines at their best.



Cellaring

Fridge temperature
(too cold)

Optimal cellaring temperature
for all wines
(red, white and Champagne)

Ambient Australian room temperature
(too hot)



Serving



IF SERVED BELOW IDEAL TEMPERATURE:

Tannins will be harsher; bitterness and acidity will be accentuated.

Sauvignon Blanc & Champagne

Chardonnay

Pinot Noir & Merlot

Cabernet Sauvignon & Shiraz

IF SERVED ABOVE IDEAL TEMPERATURE:

Aromas are stripped of their finesse and hidden by a sensation of alcohol.

VINTEC CLUB

For more expert advice and great resources on collecting, cellaring and serving wine, visit vintecclub.com

Detailed specifications

Underbench Wine Cellars

	VWSO20SBB	VWSO35SBB	VWSO35SSB	VWSO50SSB	VWSO50SBB	VWDO50SSB	VWDO50SBB
Bottle capacity*	20	35	35	50	50	50	50
Primary function	Cellar red & white	Cellar red & white	Cellar red & white	Cellar red & white	Cellar red & white	Zone 1: Serve red Zone 2: Serve white	Zone 1: Serve red Zone 2: Serve white
Alternate function	Serve red or white	Serve red or white	Serve red or white	Serve red or white	Serve red or white	Zone 1: Serve Zone 2: Cellar	Zone 1: Serve Zone 2: Cellar
Finish	Black glass	Black glass	Stainless steel	Stainless steel	Black glass	Stainless steel	Black glass
Temperature zones	1	1	1	1	1 °C	2	2
Temperature ranges (°C)	6°C to 18°C	6°C to 18°C	6°C to 18°C	6°C to 18°C	6°C to 18°C	Zone 1: 6°C-12°C Zone 2: 12°C-18°C	Zone 1: 6°C-12°C Zone 2: 12°C-18°C
Shelves	5 full, 1 half	3 full, 1 half	3 full, 1 half	4 full, 1 half	4 full, 1 drawer	3 full, 1 half	3 full, 1 half
Shelving material	Beechwood	Beechwood	Beechwood	Beechwood, SS front	Beechwood	Beechwood, SS front	Beechwood
Mood lighting	Crystal white LED	Crystal white LED	Crystal white LED	Crystal white LED	Crystal white LED	Crystal white LED	Crystal white LED
Door type	Glass	Glass	Glass	Glass	Glass	Glass	Glass
Built-in or freestanding only	Both	Freestanding only	Freestanding only	Both	Both	Both	Both
Stabilised temperature control	✓	✓	✓	✓	✓	✓	✓
Dark storage area²	✓	✓	✓	✓	✓	✓	✓
Vibration reduction system	✓	✓	✓	✓	✓	✓	✓
Frequent air circulation	✓	✓	✓	✓	✓	✓	✓
Lock	✓			✓	✓	✓	✓
Winter heating function						✓	✓
LED display panel	✓	✓	✓	✓	✓	✓	✓
Alarm (audible and visual)							
Alarm (visual only)							
Energy efficient R600a gas	✓	✓	✓	✓	✓	✓	✓
Reversible door	✓	✓	✓	✓	✓	✓	✓
Dimensions (H x W x D) (mm)	820 x 295 x 575	830 x 493 x 577	830 x 493 x 588	820 x 595 x 563	820 x 595 x 563	820 x 595 x 563	820 x 595 x 563
Rear spacer³ (mm)	30	30	30	30	30	30	30
Front or rear venting	Front	NA	NA	Front	Front	Front	Front
Body colour	Black	Black	Black	Black	Black	Black	Black
Door supplied right or left hinged	RH	RH	RH	RH	RH	RH	RH
Weight (kg)	28	39	40	47	52	48	52
Electricity consumption⁴ (kWh/day)	1	1	1	1	1	1	1
Rated voltage (V)	220-240	220-240	220-240	220-240	220 - 240	220-240	220 - 240
Glazing and UV-treatment	Triple glazed, UV	Triple glazed, UV	Triple glazed, UV	Triple glazed, UV	Triple glazed, UV	Triple glazed, UV	Triple glazed, UV

Note: While product specifications are accurate at the time of printing, changes and improvements can occur at any time
 * Max capacity, based on that achieved in our testing using standard 750ml Bordeaux style wine bottles or 330ml beer bottles
 1 When set at 12 - 14° celsius
 2 Dark interiors and tinted glass
 3 Refer to install specs available at vintec.com
 4 Actual energy consumption will depend on the ambient temperature, the set temperature and how often the door is opened

Tall Wine Cellars

	PREMIUM RANGE							
	VWS13OSSB	VWS17OSSB	VWM148SBA	V190SG2E-BK	VWM198SBA	VWM198PBA	VWM306SBA	VWM306PBA
Bottle capacity*	130	170	148	198	198	126	306	180
Primary function	Cellar red & white	Cellar red & white	Serve all	Serve all	Serve all	Serve all	Serve all	Serve all
Alternate function	Serve red or white	Serve red or white	Cellar red & white	Cellar red & white	Cellar red & white	Cellar red & white	Cellar red & white	Cellar red & white
Finish	Stainless steel	Stainless steel	Black glass	Black glass	Black glass	Black glass	Black glass	Black glass
Temperature zones	1	1	1 or multi	1 or multi	1 or multi	1 or multi	1 or multi	1 or multi
Temperature ranges (°C)	6 to 18	6 to 18	6 to 22	6 to 22	5 to 20	5 to 20	5 to 20	5 to 20
Shelves	10 sliding, 1 half	14 sliding, 1 half	3 Full adjustable, 1 display shelf, 1 ¾ shelf	4 Full adjustable, 1 display shelf, 1 ¾ shelf	4 Full adjustable, 1 display shelf, 1 ¾ shelf	7 Full on telescopic slides, 1 full fixed, 1 display shelf, 1 ¾ shelf	6 Full adjustable	11 Full on telescopic slides, 1 full fixed
Shelving material	Beechwood, SS front	Beechwood, SS front	Beechwood	Beechwood	American Oak, Alum front	American Oak, Alum front	American Oak, Alum front	American Oak, Alum front
Mood lighting	Blue LED	Blue LED	Crystal white LED	Crystal white LED	Crystal white LED	Crystal white LED	Crystal white LED	Crystal white LED
Door type	Glass	Glass	Glass	Glass	Glass	Glass	Glass	Glass
Built-in or freestanding only	Both	Both	Both	Both	Both	Both	Both	Both
Stabilised temperature control	✓	✓	✓	✓	✓	✓	✓	✓
Dark storage area²	✓	✓	✓	✓	✓	✓	✓	✓
Vibration reduction system	✓	✓	✓	✓	✓	✓	✓	✓
Frequent air circulation	✓	✓	✓	✓	✓	✓	✓	✓
Lock	✓	✓	✓	✓	✓	✓	✓	✓
Winter heating function	✓	✓	✓	✓	✓	✓	✓	✓
LED display panel	✓	✓	✓	✓	✓	✓	✓	✓
Alarm (audible and visual)			✓	✓	✓	✓	✓	✓
Alarm (visual only)	✓	✓						
Inverter compressor					✓	✓	✓	✓
Energy efficient R600a gas	✓	✓	✓	✓	✓	✓	✓	✓
Reversible door	✓	✓						
Display Shelf included				✓	✓	✓	✓	✓
Display shelves available for order			✓	✓	✓	✓	✓	✓
Dimensions (H x W x D) (mm)	1400 x 595 x 680	1770 x 595 x 680	1550 x 595 x 610	1860 x 595 x 610	1850 x 595 x 610	1850 x 595 x 610	1940 x 705 x 700	1940 x 705 x 700
Rear spacer³ (mm)	30	30	30	30	30	30	30	30
Front or rear venting	Front	Front	Rear	Rear	Rear	Rear	Rear	Rear
Body colour	Black	Black	Black	Black	Black	Black	Black	Black
Door supplied right or left hinged	RH	RH	Specify	Specify	Specify	Specify	Specify	Specify
Weight (kg)	86	105	84	84	85	85	110	110
Electricity consumption⁴ (kWh/day)	1	1	1	1	1	1	1	1
Rated voltage (V)	220 - 240	220 - 240	220 - 240	220 - 240	220 - 240	220 - 240	220 - 240	220 - 240
Glazing and UV-treatment	Triple glazed, UV	Triple glazed, UV	Double glazed, UV	Double glazed, UV	Double glazed, UV	Double glazed, UV	Double glazed, UV	Double glazed, UV

Note: While product specifications are accurate at the time of publication, changes and improvements can occur at any time
 * Max capacity, based on that achieved in our testing using standard 750ml Bordeaux style wine bottles or 330ml beer bottles
 1 When set at 12 - 14° celsius
 2 Dark interiors and tinted glass
 3 Refer to install specifications available at vintec.com
 4 Actual energy consumption will depend on the ambient temperature, the set temperature and how often the door is opened

Beverage Centres

	VBSO2OSBB	VBSO5OSSB	V19OBVC-BK	VBSO5OSBB
Bottle capacity*	48 (beer)	100 (beer)	260 (beer)	100 (beer)
Primary function	Serve beer & white	Serve beer & white	Serve beer & white	Serve beer & white
Alternate function	NA	NA	NA	NA
Finish	Black glass	Stainless steel	Black glass	Black glass
Temperature zones	1	1	1	1
Temperature ranges (°C)	2 to 10	2 to 10	2 to 10	2 to 10
Shelves	3 full	3 adjustable	6 adjustable	3 adjustable
Shelving material	Metallic, wood front	Metallic, SS front	Metallic	Metallic wood front
Mood lighting	Crystal white LED	Crystal white LED	Crystal white LED	Crystal white LED
Door type	Glass	Glass	Glass	Glass
Built-in or freestanding only	Both	Both	Both	Both
Stabilised temperature control	✓	✓	✓	✓
Dark storage area²	✓	✓	✓	✓
Vibration reduction system	✓	✓	✓	✓
Frequent air circulation	✓	✓	✓	✓
Lock	✓	✓	✓	✓
LED display panel	✓	✓	✓	✓
Alarm (audible and visual)			✓	
Alarm (visual only)				
Energy efficient R600a gas	✓	✓	✓	✓
Reversible door	✓	✓		✓
Dimensions (H x W x D) (mm)	820 x 295 x 575	820 x 595 x 563	1860 x 595 x 610	820 x 595 x 563
Rear spacer³ (mm)	30	30	30	30
Front or rear venting	Front	Front	Rear	Front
Body colour	Black	Black	Black	Black
Door supplied right or left hinged	RH	RH	Specify	RH
Weight (kg)	28	47	84	52
Electricity consumption⁴ (kWh/day)	1	1	1	1
Rated voltage (V)	220-240	220-240	220 - 240	220 - 240
Glazing and UV-treatment	Triple glazed, UV	Triple glazed, UV	Double glazed, UV	Triple glazed, UV

Note: While product specifications are accurate at the time of printing, changes and improvements can occur at any time
 * Max capacity, based on that achieved in our testing using standard 750ml Bordeaux style wine bottles or 330ml beer bottles
 1 When set at 12 - 14° celsius
 2 Dark interiors and tinted glass
 3 Refer to install specs available at vintec.com
 4 Actual energy consumption will depend on the ambient temperature, the set temperature and how often the door is opened

Walk-in Cellars

	TRANSTHERM ESPACE
Bottle capacity*	1000
Primary function	Cellar red & white
Alternate function	NA
Finish	Classic black
Temperature zones	1
Temperature ranges (°C)	8 to 18
Shelves	23 sliding
Shelving material	Wood
Mood lighting	Internal light
Door type	Glass
Built-in or freestanding only	Both
Stabilised temperature control	✓
Dark storage area¹	✓
Vibration reduction system	✓
Frequent air circulation	✓
Lock	✓
Winter heating function	✓
LED display panel	✓
Dimensions (H x W x D) (mm)	2050 x 1870 x 1170
Front or rear venting	Front
Body colour	Black
Door supplied right or left hinged	RH
Weight (kg)	310
Electricity consumption² (kWh/day)	3.5 - 4
Rated voltage (V)	220 - 240
Glazing and UV-treatment	Double glazed, UV

Note: While product specifications are accurate at the time of printing, changes and improvements can occur at any time
 * Max capacity, based on that achieved in our testing using standard 750ml Bordeaux style wine bottles or 330ml beer bottles
 1 Dark interiors and tinted glass
 2 Actual energy consumption will depend on the ambient temperature, the set temperature and how often the door is opened



Warranty

Electrolux Home Products Pty Ltd and Electrolux (NZ) Limited (collectively Electrolux) warrants that for domestic applications the appliances featured in this brochure are free from defects in materials and workmanship for 2 years and warrants that for featured accessories a period of 12 months, following the date of original purchase and subject to the conditions set out in the warranty card accompanying the product when purchased. This warranty is in addition to the other rights and warranties you may have under the Australian Consumer Law (ACL) and Electrolux will at all times comply with its obligations at law including the ACL. For New Zealand customers Electrolux will at all times comply with its obligations pursuant to law including the Consumer Guarantees Act, the Sale of Goods Act and the Fair Trading Act. Where appliances are purchased in NZ for commercial purposes the Consumer Guarantees Act does not apply.

Product information

The descriptors and illustrations in this publication apply to the specific products and models described as at the date of issue. Under our policy of continuous product development, product specifications may change without notice. Prospective purchasers should therefore check with their retailer to ensure this publication correctly describes the products that are being offered for sale.

All information supplied is to be used for general reference purposes only and is on the understanding that Electrolux will not be liable for any loss, liability or damage of whatever kind arising as a result of reliance on such information. Electrolux will at all times comply with its obligations pursuant to law. Colours of products illustrated are as close as printing limitations allow.

Photo: 3x V190BVC-BK installed at Cirrus Dining, Sydney.

VINTEC

Vintec. We are part of the Electrolux Family. To add a touch of professional inspiration to your home, visit electrolux.com.au or electrolux.co.nz.

Electrolux Home
Products Australia
1800 666 778
vintec.com

© 2022 Electrolux Home Products Pty Ltd.
ABN 51 004 762 341
V_BRO_VintecMaster_May22